

BRAND BOOSTER

The all-inclusive brand stand display solution...

- Modular
- Individual branding
- Durable construction
- Easy DIY assembly
- Lightweight
- Versatile
- Various sizes



The Brand Booster stand is available in 12 sizes

Pick yours:

180mm shelf spacing

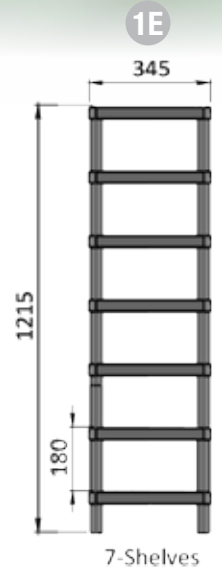
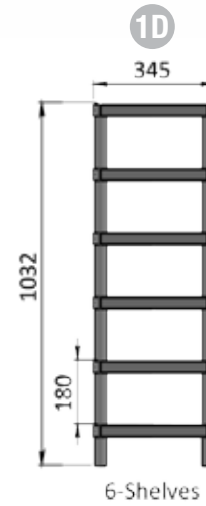
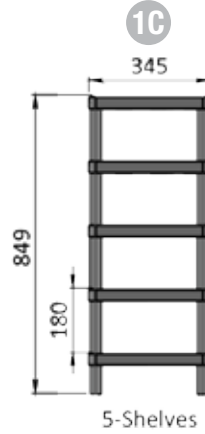
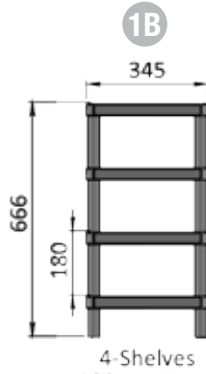
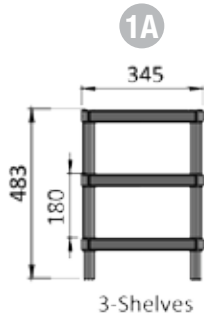

250mm shelf spacing

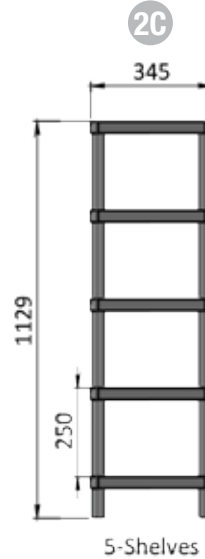
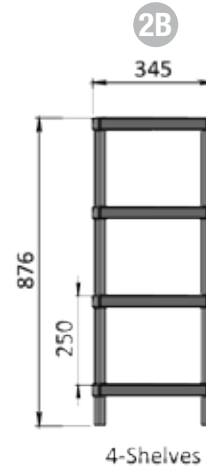
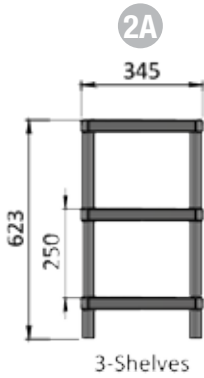

320mm shelf spacing

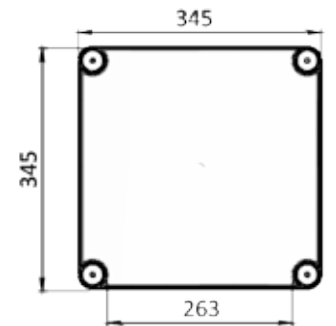
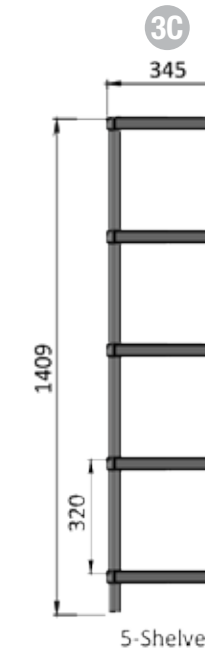
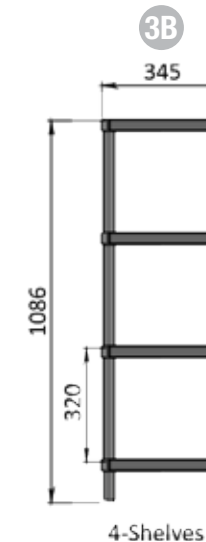
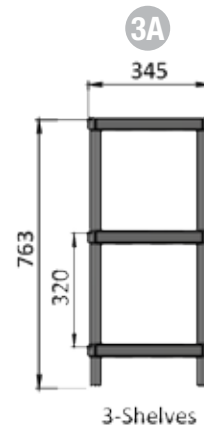

*more than 100 units subject to quotation and timelines



Single stands can be used in small areas or multiple stands can be connected together for larger displays.

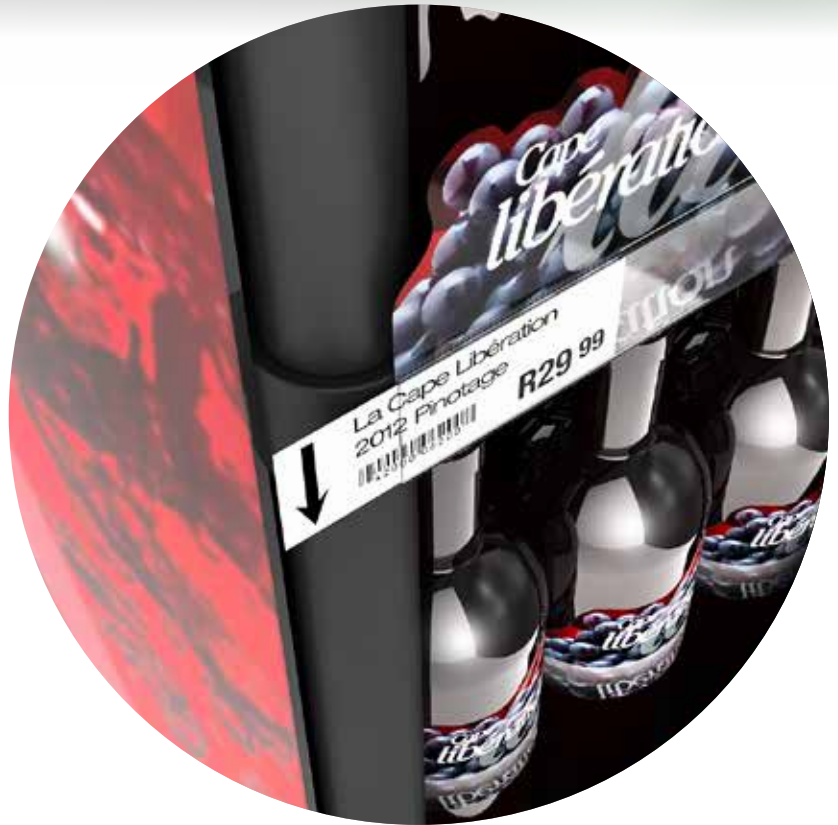

Shelf Price labelling
(optional extra)



Branding and artwork (optional extra) can be set up to your specifications.

What is it?

The Brand Booster can be anything from a small counter brand stand, to a fully-branded freestanding product showcase.

1 Pick a frame that suits your needs:

- 12 sizes available
- Standard colours: white & black
- Special colours are subject to minimum quantities*
- Durable and strong:
- Semi-permanent:
- Budget-friendly & sustainable
- Flat-pack for efficient distribution
- Recessed shelves stabilise product
- Assembly instructions included
- Class-leading 345x345mm footprint

* Enquire with Kyta if you would like a special colour stand

* shelf price strip, end-caps and rubber feet are optional extras

2 Ask Kyta about artwork options:

Our in-house design department can set up or design your artwork for printing on our in-house digital printer.

Cladding sets are supplied flat-pack including relevant fasteners and accessories.

Unbranded stands subject to minimum quantity of 5 units of one colour.

Branded stands subject to minimum quantity of 50 units of the same colour and design.

Artwork set-up and sampling for approval only completed after order confirmation.

